

Glass cutting tables

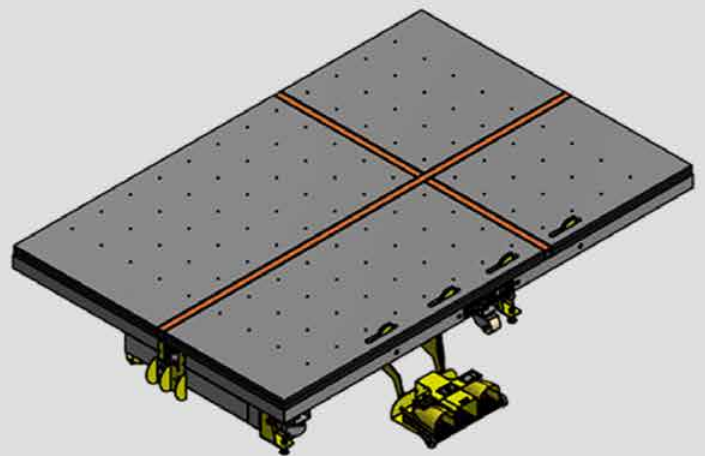

Dimension	A	B	C	D	E
SDRM	2800	1860	1640	920	1070
SDRD	3400	2400	2240		1380
SDRXL	3400	2600			

Glass cutting tables

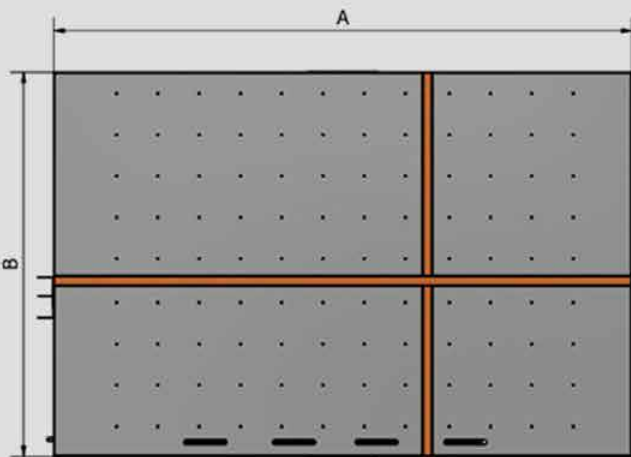
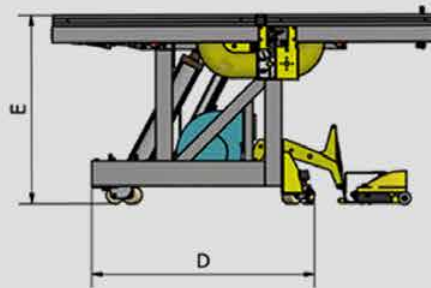
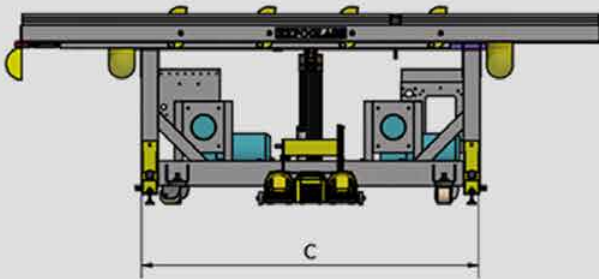
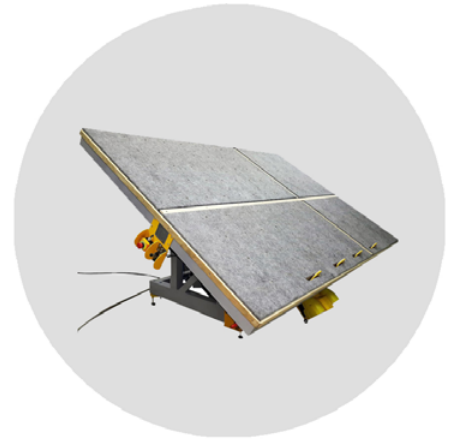
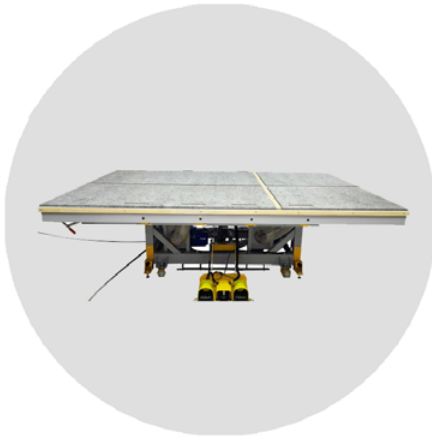
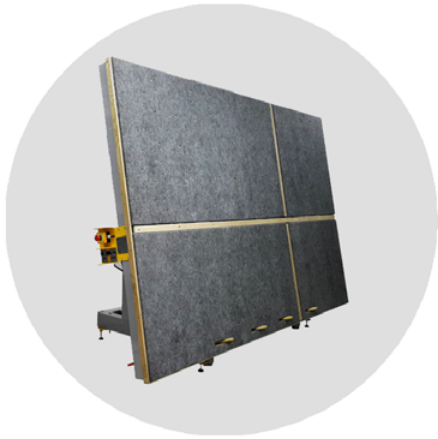

The purpose of use

Expoglass glass cutting table is a machine which makes operation of glass cutting: easier, faster and safer. Usually it also reduces the number of necessary operators during the glass cutting process. The main three features which helps in glass cutting are: tilted top, breaking bars and air cushion system.

Loading the glass

The basic function of all glass cutting tables is to enable safe and convenient glass loading. Glass sheets, should be handled in a vertical orientation, otherwise they could break under their own weight. In our tables, in order to be able to put the sheets on the table safely and comfortably, it is enough to pull out the loading cantilevers from the table top, tilt the table top to an inclined position and place the panes on the brackets.

Breaking the glass

Breaking bars greatly improve the glass breaking process. After scoring the glass, it is enough to set the surface in such a way that the score is located above the bar and press the pedal under the table. Pressing the pedal causes the breaking bar to lift, pushing from the bottom along the score on the glass and the material breaks under its own weight. Depending on the orientation in which we cut the glass, we can use breakers - longitudinal or transversal.

Manipulating large and / or heavy panels

While manipulating large and / or thick glass sheets, large friction is generated on the worktop surface. This phenomenon makes it difficult for the operator to work, and in some cases may unable the operator to operate alone. An additional risk is scratching of the glass at the moment when there are pieces of glass or other dirt on the table. The occurrence of these problems can be minimized by using an aircushion system.

Glass cutting tables

Advantages of using

Safety of operation

- Safe vertical loading
- Breaking with bars
- Foot panel hiding during the tilting of the top

Higher effectiveness and reduction of the number of operators

- Fast breaking of the glass
- Efficient manipulating thanks to air cushion system

Less material loss

- Less scores on glass thanks to air cushion system
- Higher quality of edge after breaking the glass with bars
- Less risk of failure while breaking the glass



Glass cutting tables

Long-term use thanks to highest quality

- Whole production takes place in Europe
- All of the parts are high quality
- All spare parts are available

Ergonomics

- 2 x 230V industrial sockets
- Whole design process focused on our and clients' experience

Mobility

- All tables equipped with wheels
- Tables with tilted top need 1/3 less space

